

GRUNDIG

GX-4308

User Manual



Initial Setup

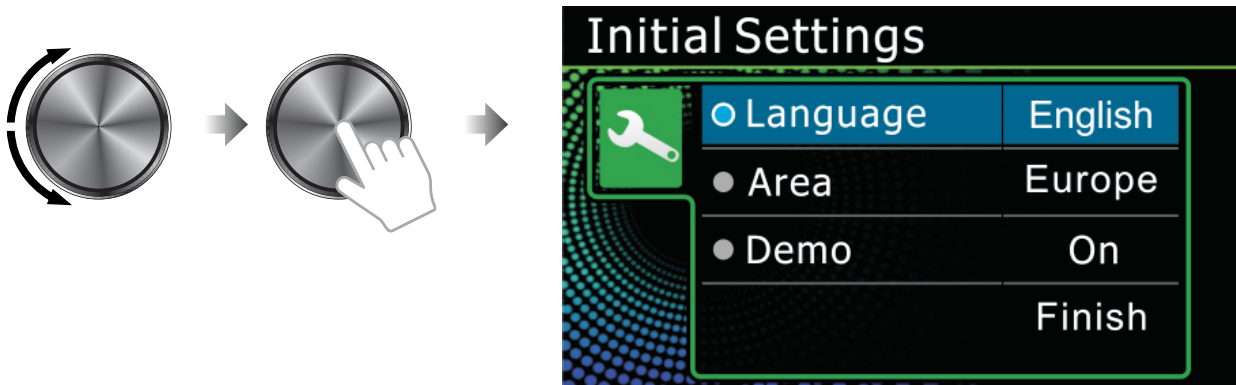

Please select the suitable Language/Country Area, and rotate the volume knob to select the **Finish** to confirm.



Perform this setup when you use this unit first time.

Overview Of The Unit

◆ Functions of the Buttons on the Head Unit

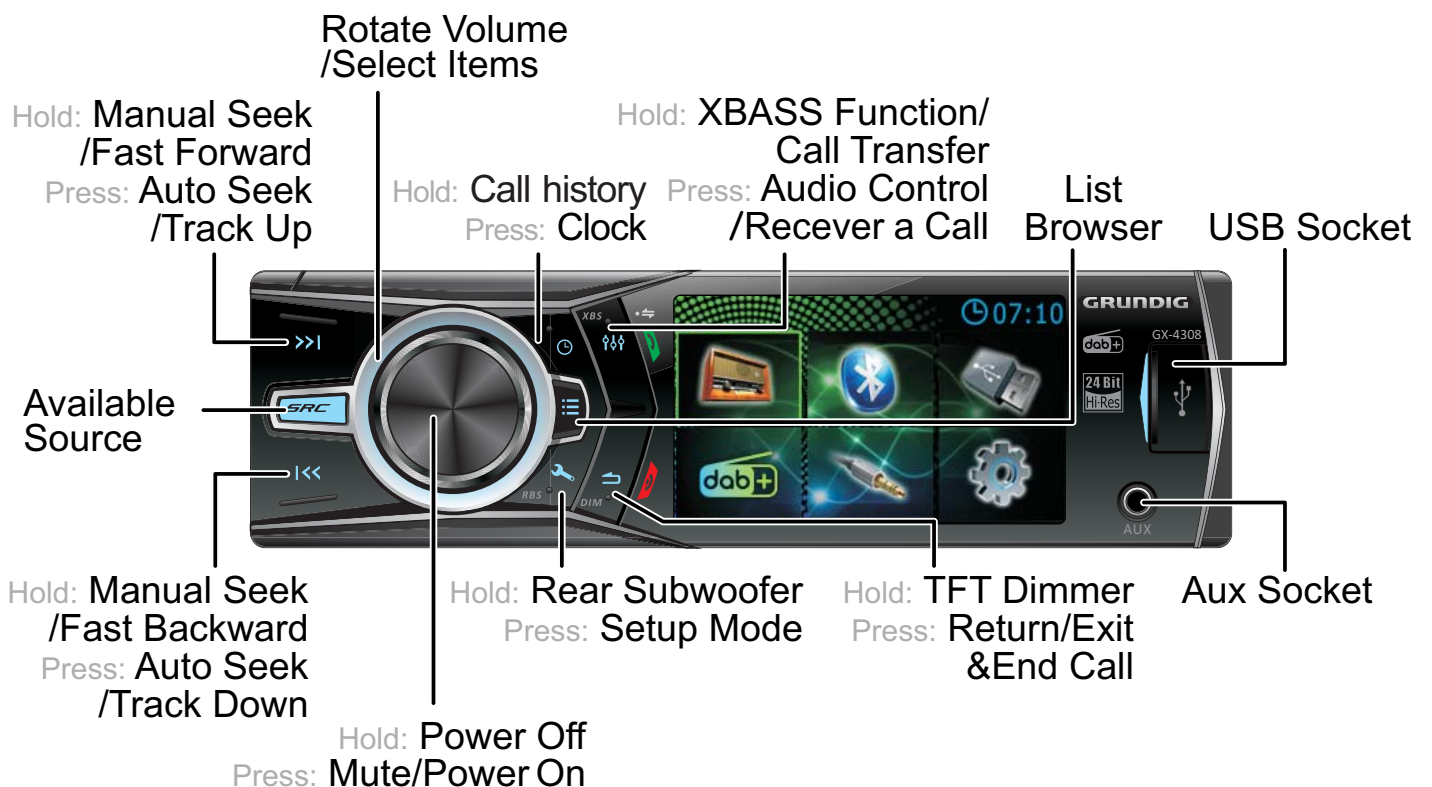

◆ Select Source

1. Access to Menu



2. Select source



◆ Setup Menu Settings

◆ Access to Setup Menu

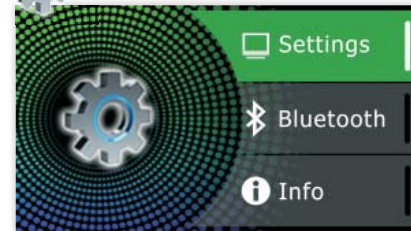

Access to General Settings

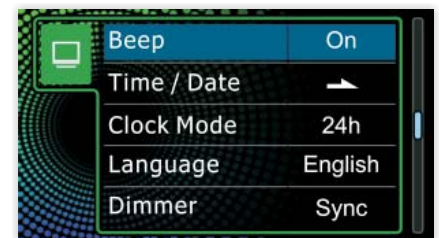

◆ Mute

Press the  button to mute or restore volume.

◆ Volume Adjustment

Rotate the  knob on the front panel to increase / decrease the volume.

◆ Clock

Press  button on front panel to view the clock.

◆ Dimmer

Press and hold  button on front panel to adjust the LCD display backligh.



◆ Selecting The Radio Band

Press the  button on the front panel to access the Preset List to select the Band



◆ Manual Seek

Press [**1<<<**] or [**>>>1**] to tune to a radio station manually.
The radio station is broadcast.

◆ Auto Seek



Press and hold [**1<<<**] or [**>>>1**] to tune to search for a radio station automatically,

◆ Preset Station

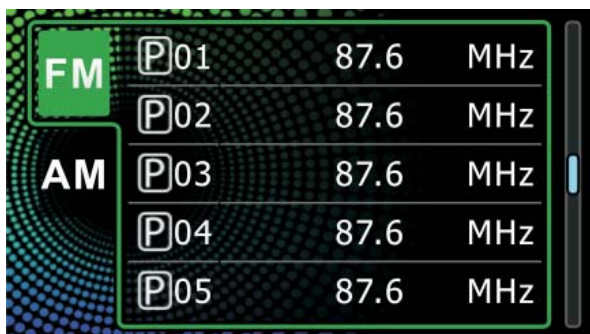
1. Press  button on front panel to display the preset list.
2. Rotate  to select the Preset Station, then press  to make selection.



◆ Radio Function Settings

1. Press  to display the function menu.
2. Rotate  to select the item to be adjusted, then press  to make selection.

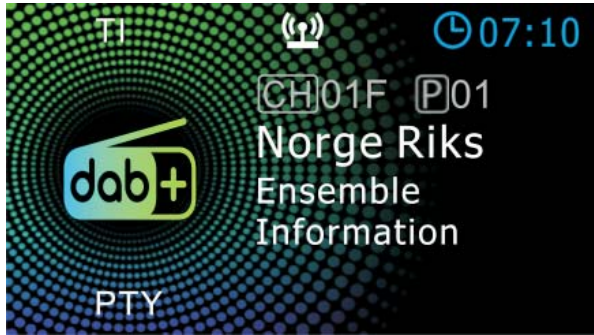

Item	Selectable setting
Manual Store	Stores a station manually. While listening to a station you want to store, turn the volume knob to select a preset number, then press the knob.
Auto Store	Automatically searches and stores the stations with the strongest signals for the selected band.
Area	Select suitable country area for this unit: EUROPE; RUSSIA; JAPAN; LATIN; MID-EAST; OCEANIA; USA; ASIA
Local Seek	<ul style="list-style-type: none"> • ON: only stations with strong signal can be broadcast. The Local indicator will light up. • OFF: Stations of both strong and weak signals can be broadcast.
RDS	Turn On or Off the RDS function.
AF	When station reception is poor, automatically switches to the station that is broadcasting the same program over the same Radio Data System network.
TA	Switches to the traffic information automatically when the traffic bulletin starts.
CT	Turn on the RDS clock. Time shown on the unit will synchronize with the clock time of the RDS station.
PTY	Once inside the PTY mode, press the get into program type item, and rotate encoder volume knob to selected category.



◆ DAB radio station manually



1. Press [|<<] or [>>|] to search for an ensemble automatically.
2. Press and hold [|<<] or [>>|] repeatedly to search for an ensemble manually.

◆ DAB Service Station

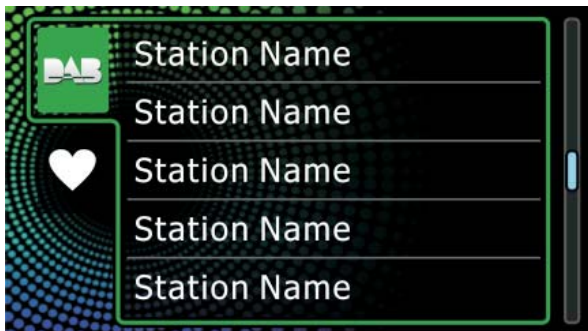
1. Press  button on front panel to display the DAB Service List.
2. Rotate  to select a Service, then press  to make selection.



◆ DAB Function Settings

1. Press  to display the function menu.
2. Rotate  to select the item to be adjusted, then press  to make selection.

Item	Selectable setting
Add Favor	Stores a service While listening to a service you want to store, turn the volume knob to select a preset number, then press the knob.
Scan Station	Updates the DAB Service List.
Zoom DLS	Display the Dynamic Label Segment screen.
PTY Search	Searches for a program by program type
TI	Switches to the traffic information automatically when the traffic bulletin starts
Setup	<ul style="list-style-type: none"> • Priority If the same service is provided by Radio Data System when reception of the service being provided by Digital Radio becomes poor, automatically switches to Radio Data System. • Related Service When you select ON, the unit switches to a related service (if exists) when a DAB service network is not available. • Antenna Power Sets power supply to the Digital Radio antenna. Set to "ON" when the Digital Radio antenna in use is equipped with a booster.
Information	On the display of DAB broadcasting, the first line shows station name, and the second line shows the service information for the current station.
Reset	Select [Reset] and then select [Yes] to set the DAB settings to the initial default settings.

◆ Source Screen

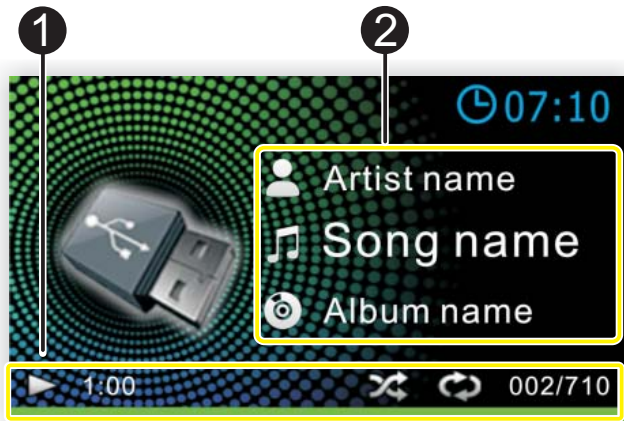

- | | |
|----------|---|
| 1 | <p>Play time bar: For confirmation of current playing position</p> <p> Repeat playback mode indicator</p> <p> Random playback mode indicator</p> |
| 2 | Displays the information of the current file. |

◆ Play / Pause

Press the button to play or pause audio playback.

◆ Selecting a Track

1. Press the [/] buttons to move to the beginning of the previous/next track.
2. Press and hold the [/] buttons to fast forward/backford.

◆ Music Function Settings

1. Press to display the function menu.
2. Rotate to select the item to be adjusted, then press to make selection.

Repeat	All:Repeats all files() One:Repeats current file() Folder:Repeat all files in current folder()
Random	Off:Normal playback On:Randomly plays all files()

◆ Selecting a Track In a List

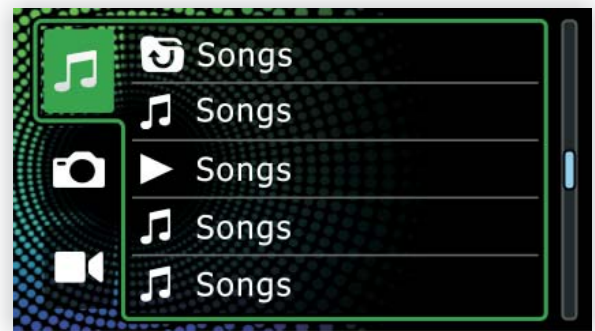

1. Press button on front panel to display the Playback List.
2. Rotate to select the items:
 - Audio Files []
 - Video Files []
 - Picture Files []

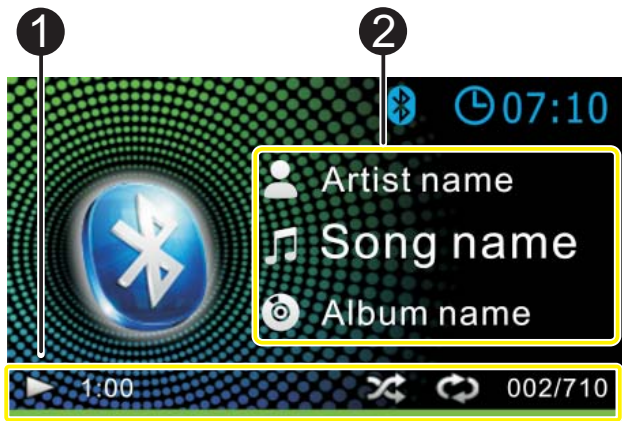

3. Rotate to select the desired folder, then press to confirm.
4. Rotate to select the desired item, then press to starts playback.

◆ Source Screen







- | | |
|----------|--|
| 1 | Play time bar: For confirmation of current playing position
 Repeat playback mode indicator
 Random playback mode indicator |
| 2 | Displays the information of the current file. |



◆ Play / Pause



Press the  button to play or pause audio playback.

◆ Selecting a Track

1. Press the [ ] buttons to move to the beginning of the previous/next track.
2. Press and hold the [ ] buttons to fast forward/backford.



◆ Music Function Settings

1. Press  to display the function menu.
2. Rotate  to select the item to be adjusted, then press  to make selection.





Repeat	All:Repeats all files()
	One:Repeats current file()
	Folder:Repeat all files in current folder()

Random	Off:Normal playback
	On:Randomly plays all files()

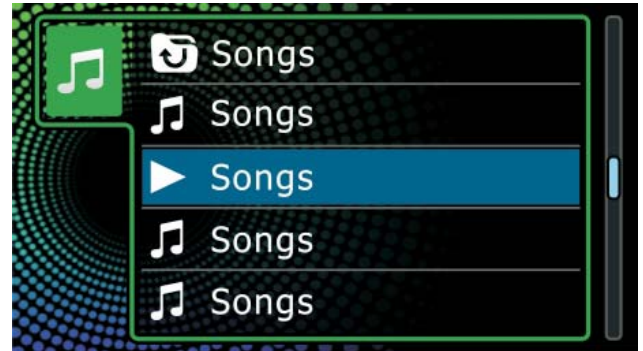



◆ Selecting a Track In a List

1. Press  button on front panel to display the Playback List.
2. Rotate  to select whether you search by audio files [].



3. Rotate  to select the desired folder, then press  to confirm.
4. Rotate  to select the desired item, then press  to starts playback.

◆ Bluetooth Settings

1. Press  button on front panel to display the available Source.
2. Rotate  to select the settins , then press  to confirm.

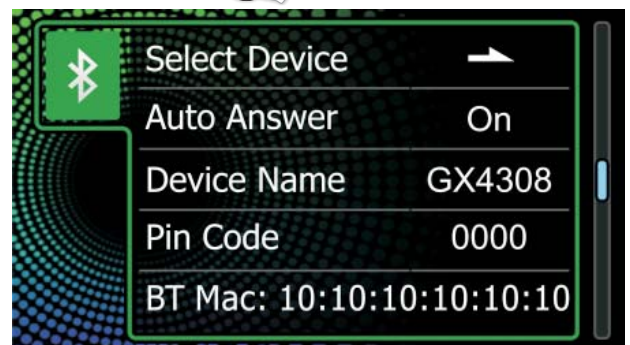



◆ Making a Call

You can dial number through the mobile phone.

1. Use the Mobile Phone to dial and make an outgoing call
2. Once completed the dialing, the phone number and [CALL---] is displayed.





◆ Receiving a Call

1. If there is an incoming call, the phone number will be displayed.
2. Press  to answer/accept the call.
3. When conversation ends, press  to terminate the call.

◆ Call Transfer





You can transfer voice from car speakers to mobile phones during a telephone conversation. During a telephone conversation, press and hold  voice transfers from car speakers to mobile phone.

◆ Call History

1. Press and hold  to display the Call history.
2. Rotate  to select the items:
 - Call history list []
 - Phonebook []
 - Voice Assistant []



You can access the voice recognition function of the phone connected to this Car AV System.

1. Press  on front panel to access into the Audio Settings Mode adjust the various settings.
2. Rotate  to select the desired items to adjust, then press  to confirm.
3. Rotate  to select a value/option.

◆ Preset EQ

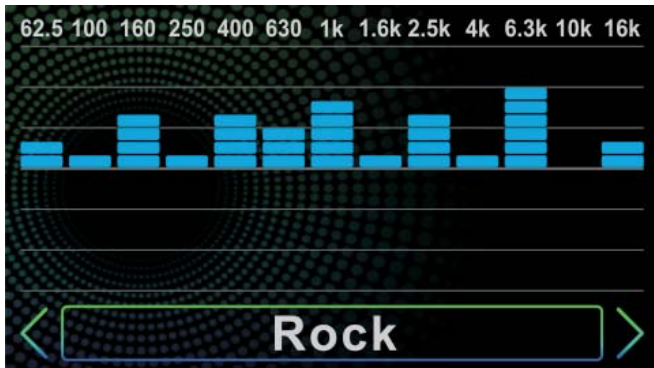

◆ Speaker



- **[Balance]**: Adjust the left and right volume balance.
- **[Fader]**: Adjust the front and rear volume balance.

◆ XBass



- Sets the Bass Booster/Bass Dynamic

◆ Crossover



- **[Prequence]**: To adjust the High/Low Pass filter.
- **[SLOPE]**: To set a crossover slope.
- **[LEVEL]**: To Adjust the gain of the front speaker, rear speaker, or subwoofer.

◆ Virtual Subwoofer



- Turn the Rear Speakers to Virtual Subwoofer. Enjoy the powerful Bass without install any real subwoofer.

◆ Delay



- Adjust the delay time of the selected speaker

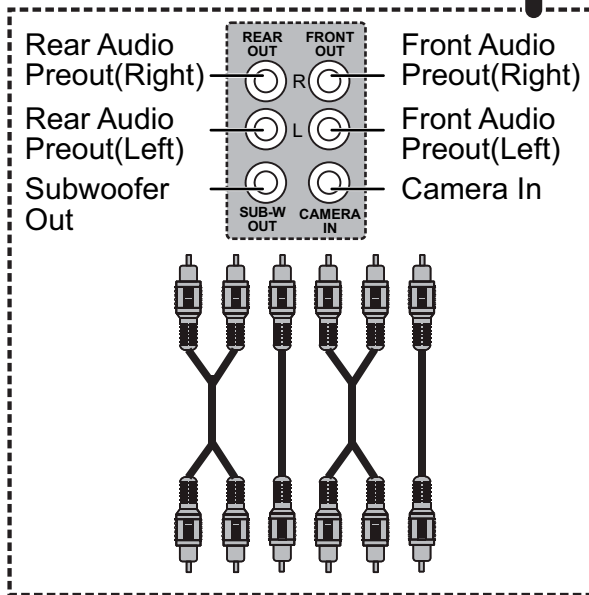
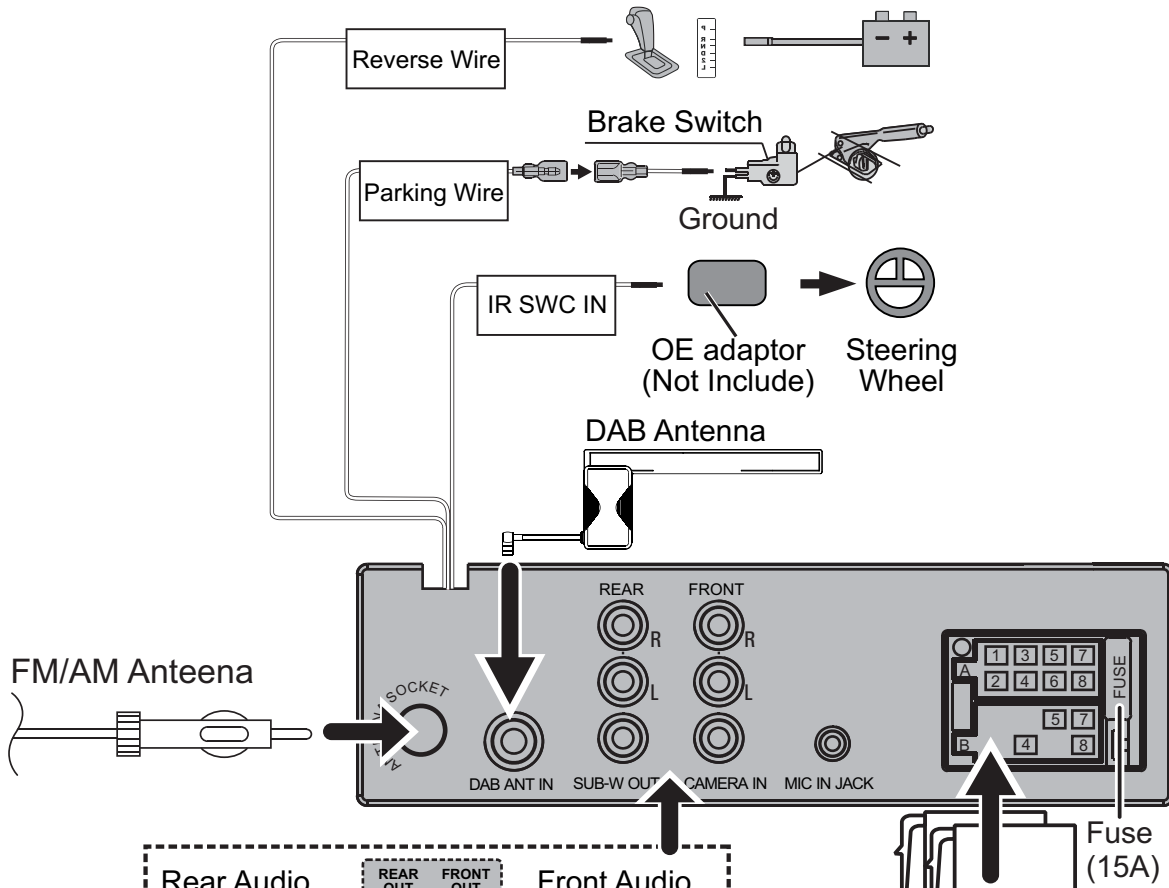

ISO Connector

Pin	Color and Function	
A4	Yellow	Battery(+)
A5	Blue/White	Power Control
A7	Red	Ignition(ACC)
A8	Black	Earth (Ground) Connection
B1/B2	Purple(+)/Purple Black(-)	Rear Right
B3/B4	Gray(+)/Gray Black(-)	Front Right
B5/B6	White(+)/White Black(-)	Front Left
B7/B8	Green(+)/Green Black(-)	Rear Left

Window Shield Mount DAB Antenna

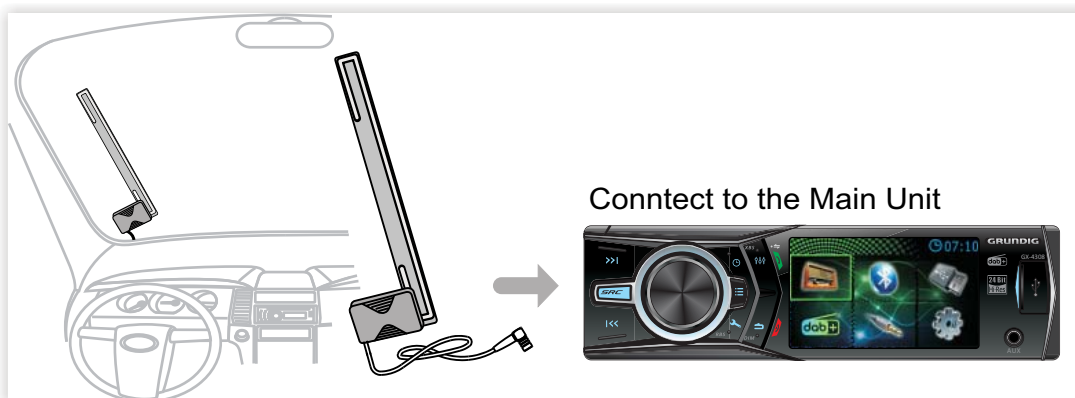

TFT Monitor section

Screen Size :3.0 inches
Contrast Ratio :500

USB interface section

USB Standard :USB 2.0 Full Speed
File System :FAT 16/32
Maximum Current :DC 5V===1.5A
D/A Converter :24Bit

Bluetooth section

Communication System : Bluetooth Ver 4.1
Output : Bluetooth Standard Power Class 2
Maximum Communication Range : Approx. 10meters
Frequency Band : 2.4 GHz
Compatible Bluetooth Profiles : HFP/SPP/A2DP/AVRCP /PBAP
Supported Codecs : SBC (Sub Band Codec)

Radio section

Frequency FM range : 87.5-108.0MHz
Frequency AM (MW) range : 522-1620 KHz
Usable sensitivity : 13.2 uV (FM)
: 44.7 uV (AM)(MW)

DAB section

Frequency range : 174-240MHz
Sensitivity : -100dBm(Band III)
Sensitivity : 40dB

Video section

Color System of External Video Input : NTSC/PAL
External Video Input : 1 Vp-p /75 Ω
(RCA/3.5m Jack)

Audio section

Maximum Power : 50Wx4
Continuous Power Output (RMS) : 22 Wx4
Preout Level (V) : 4V/10k Ω
Preout Impedance : ≤ 1.3k Ω
Speaker Impedance : 4-8 Ω
Output Frequency Band : 20-20000Hz

General

Operating Voltage :14.4V(10.5-16V)
Operational Temperature Range : -20° C--+70° C
Maximum Current Consumption :15A

Indledende opsætning

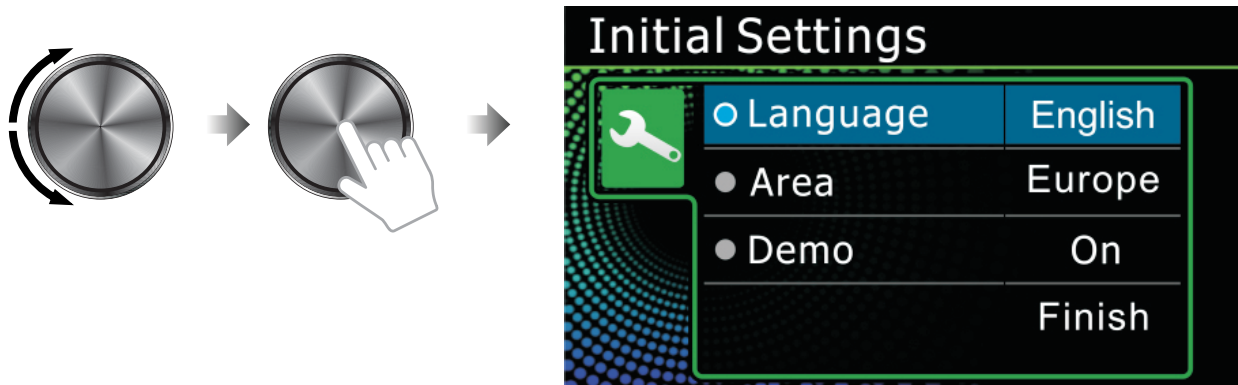

Vælg det relevante sprog/geografiske område, og drej lydstyrkeknappen for at vælge og **Finish** for at bekræfte.



Udfør denne opsætning, når du anvender enheden.

Oversigt over enheden

◆ Hovedenhedens knapfunktioner

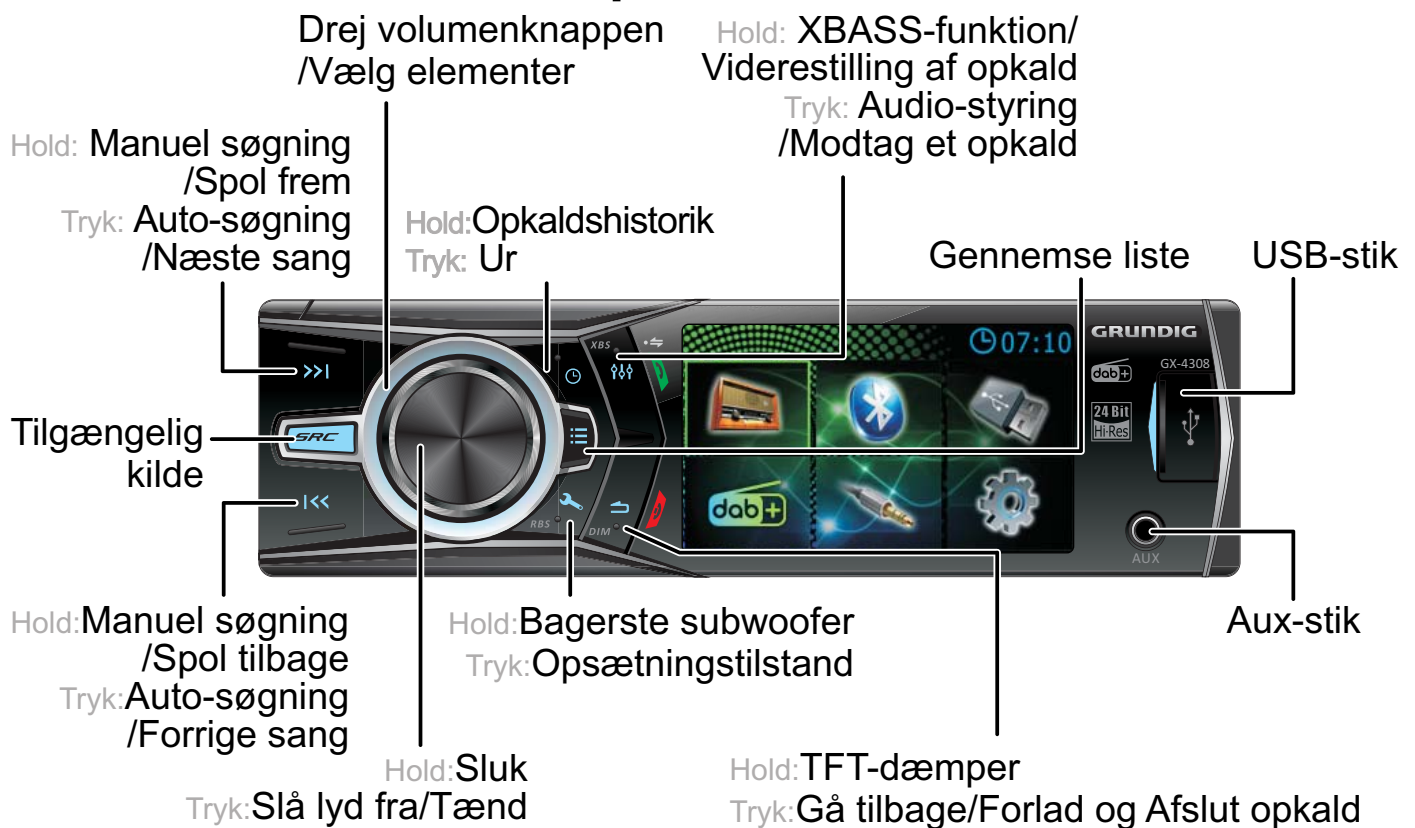

◆ Vælg kilde opsætning

1. Adgang til menuen



2. Vælg kilde



◆ Menuindstillinger for Adgang til opsætningsmenuen

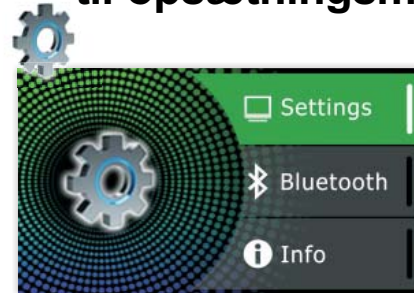

Adgang til generelle indstillinger

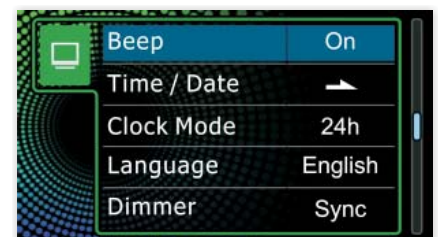

◆ Slå lyd fra

Tryk på -knappen for at slå lyden fra eller genoprette lydstyrken.

◆ Justering af lydstyrken

Drej på  knappen på frontpanelet for at skru op/ ned for lydstyrken.

◆ Ur

Tryk på -knappen på frontpanelet for at se uret.

◆ Dæmper

Tryk på -knappen på frontpanelet og hold den inde for at justere baggrundslyset i LCD-displayet.



◆ Vælg radiobånd

Tryk på -knappen på frontpanelet for at få adgang til den forudindstillede liste, så der kan vælges radiobånd

◆ Manuel søgning

Tryk på [|<<] eller [>>|] for at finde en radiostation manuelt.
Radiostationen modtages.

◆ Auto-søgning

Tryk på [|<<] eller [>>|] og hold den inde for at gå til søgning efter en radio station automatisk.

◆ Forudindstillet radiostation

1. Tryk på -knappen på frontpanelet for at få vist den forudindstillede liste.
2. Drej for at vælge den forudindstillede radiostation, og tryk derefter på for at foretage valget.

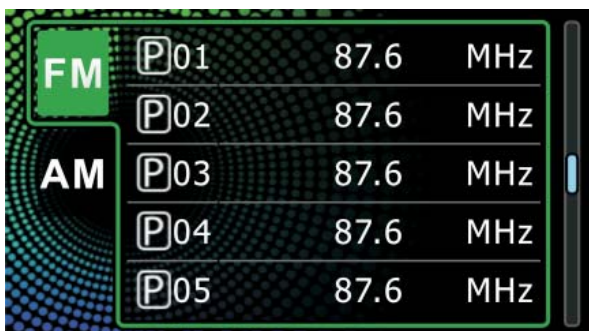

◆ Indstillinger for radiofunktion

1. Tryk på for at få vist funktionsmenuen.
2. Drej for at vælge det element, der skal justeres, og tryk derefter på for at foretage valget.

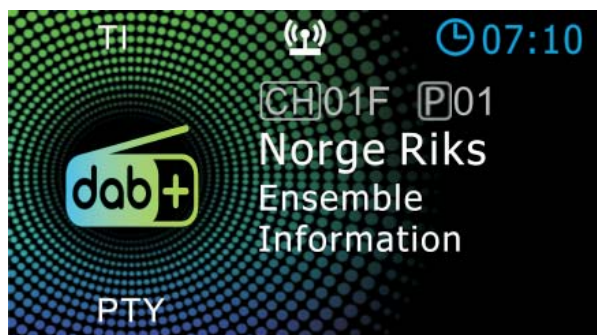

Element	Valgbar indstilling
Gem manuelt	Gemmer en radiostation manuelt. Mens du lytter til den radiostation, du gerne vil gemme, skal du dreje på lydstyrkeknappen for at vælge et forudindstillet nummer, og derefter skal du trykke på knappen.
Gem automatisk	Søger efter og gemmer automatisk de radiostationer, som har de stærkeste signaler til det valgte bånd.
Område	Vælg en egnet region til enheden: EUROPA; RUSLAND; JAPAN; LATINAMERIKA; MELLEMLØSTEN; OCEANIEN; USA; ASIEN
Lokal søgning	<ul style="list-style-type: none"> • ON: Kun radiostationer med et stærkt signal kan modtages. Local-indikatoren lyser. • OFF: Både radiostationer med stærke og svage signaler kan modtages.
RDS	Aktivér eller deaktivér RDS-funktionen.
AF	Når radiostationen har en svag modtagelse, skiftes der automatisk til den radiostation, der sender det samme program over det samme netværk for radiodatasystemet.
TA	Skifter automatisk til trafikinformation, når trafikudsendelsen starter.
CT	Aktivér RDS-uret. Klokkeslættet, der vises på enheden, synkroniseres med RDS-stationens klokkeslæt.
PTY	Når du har aktiveret PTY-tilstand, skal du trykke for at komme til programtypepunktet og dreje vælger-/lydstyrkeknappen til den valgte kategori.



◆ Manuel DAB-radiostation



1. Tryk på [|<<] eller [>> |] for at søge efter en radiostation automatisk.
2. Tryk på [|<<] eller [>> |] og hold den inde flere gange for at søge efter en radiostation manuelt.

◆ DAB-servicestation

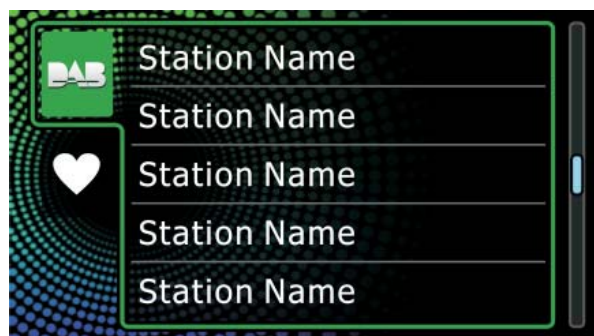
1. Tryk på  -knappen på frontpanelet for at få vist DAB-servicelisten.
2. Drej  for at vælge en service, og tryk derefter på  for at foretage et valg.



◆ DAB-funktionsindsillinger

1. Tryk på  for at få vist funktionsmenuen.
2. Drej  for at vælge det element, der skal justeres, og tryk derefter på  for at foretage et valg.

Element	Valgbar indstilling
Tilføj favorit	Gemmer en service Mens du lytter til en service, som du ønsker at gemme, skal du dreje lydstyrkeknappen for at vælge et forudindstillet nummer. Tryk derefter på knappen.
Scan radio station	Opdaterer DAB-servicelisten.
Zoom DLS	Viser skærmen for Dynamic Label Segment .
PTY Søg	Søger efter et program baseret på programtype
TI	Skifter til trafikinformation automatisk, når trafikudsendelsen starter
Opsætning	<ul style="list-style-type: none"> • Prioritet Hvis den samme service udbydes af radiodatasystemet, når modtagelsen af den pågældende service, der udbydes af den digitale radio, bliver ringe, skiftes der automatisk til radiodatasystemet. • Relateret service Når du vælger ON, skifter enheden til en relateret service (hvis den findes), når DAB-servicenetværket ikke er tilgængeligt. • Strøm til antenne Indstiller strømforsyningen til den digitale radios antenne. Indstil til ON, når den anvendte digitale radios antenne er udstyret med en booster.
Information	På displayet for DAB-modtagelse viser den første linje radiostationens navn, og den anden linje viser serviceinformation for den aktuelle radiostation.
Nulstilling	Vælg [Nulstil], og vælg dernæst [Ja] for at indstille DAB-indstillingerne til de oprindelige standardindstillinger.

◆ Kildeskærm

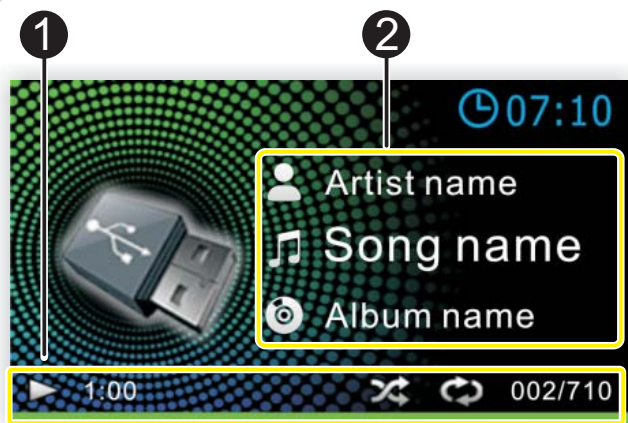

◆ Vælg et nummer på en liste

1. Tryk på -knappen på frontpanelet for at få vist afspilningslisten.
2. Drej for at vælge elementerne:
 - Lydfiler []
 - Videofiler []
 - Billedfiler []

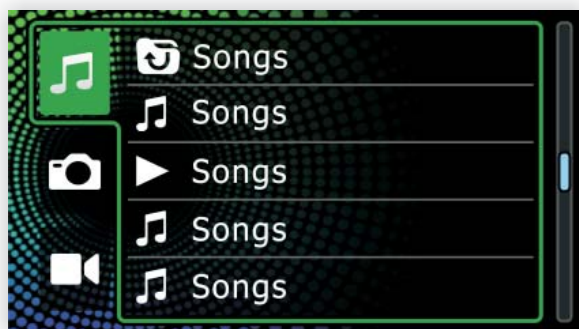

3. Drej for at vælge den ønskede mappe, og tryk dernæst på for at bekræfte.
4. Drej for at vælge det ønskede element, og tryk dernæst på for at starte afspilning.

1	<p>Bjælke for afspilningstid: Til bekræftelse af den aktuelle afspilningsposition</p> <p> Indikator for gentag afspilningstilstand</p> <p> Indikator for vilkårlig afspilningstilstand</p>
2	Viser information om den aktuelle fil.

◆ Afspil/pause

Tryk på -knappen for at afspille eller pause lydafspilning.

◆ Valg af nummer

1. Tryk på [/]-knapperne for at gå til starten på det foregående/næste nummer.
2. Tryk på [/]-knapperne og hold dem inde for at spole frem/tilbage.

◆ Indstillinger for musikfunktion



1. Tryk på for at få vist funktionsmenuen.
2. Drej for at vælge det element, der skal justeres, og tryk derefter på for at foretage valget.

Gentage Alle: Gentager alle filer ()
 Én: Gentager den aktuelle fil ()
 Mappe: Gentag alle aktuelle filer folder ()

Tilfældig Fra: Normal afspilning
 Til: Afspiller tilfældigt alle filer()

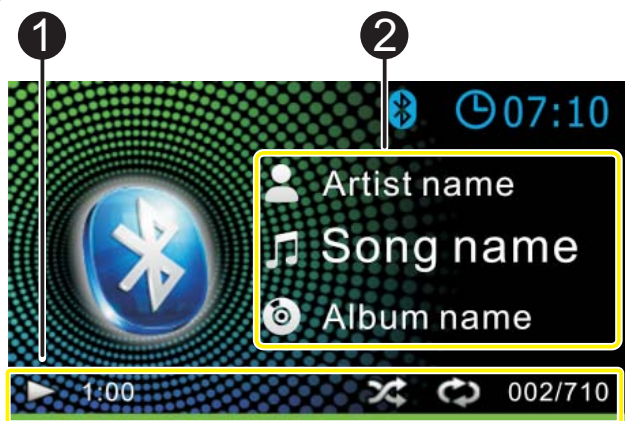
◆ Kildeskærm







- | | |
|----------|--|
| 1 | Bjælke for afspilningstid: Til bekræftelse af den aktuelle afspilningsposition

Indikator for gentag afspilningstilstand

Indikator for vilkårlig afspilningstilstand |
| 2 | Viser information om den aktuelle fil. |



◆ Afspil/pause



Tryk på -knappen for at afspille eller pause lydafspilning.

◆ Valg af nummer

- Tryk på [ << / >> ]-knapperne for at gå til starten på det foregående/næste nummer.
- Tryk på [ << / >> ]-knapperne og hold dem inde for at spole frem/tilbage.



◆ Indstillinger for musikfunktion

- Tryk på  for at få vist funktionsmenuen.
- Drej  for at vælge det element, der skal justeres, og tryk derefter på  for at foretage valget.





Gentage	Alle: Gentager alle filer ()
	En: Gentager den aktuelle fil ()
	Mappe: Gentag alle aktuelle filer folder ()

Tilfældig	Fra: Normal afspilning
	Til: Afspiller tilfældigt alle filer()

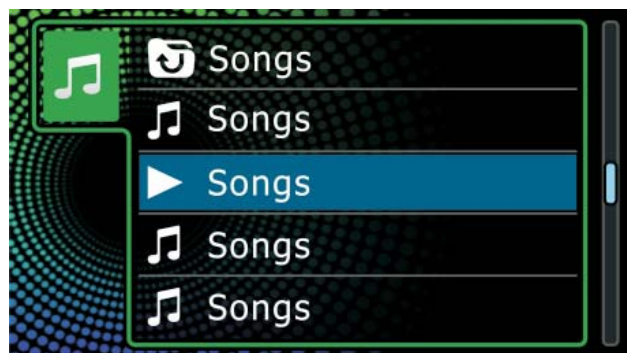



◆ Vælg et nummer på en liste

- Tryk på -knappen på frontpanelet for at få vist afspilningslisten.
- Drej  for at vælge, om du søger baseret på lydfiler [].



- Drej  for at vælge den ønskede mappe, og tryk dernæst på  for at bekræfte.
- Drej  for at vælge det ønskede element, og tryk derefter på  for at starte afspilning.

◆ Bluetooth-indstillinger

- Tryk på -knappen på frontpanelet for at få vist den tilgængelige kilde.
- Drej  for at vælge indstillingerne , og tryk dernæst på  for at bekræfte.

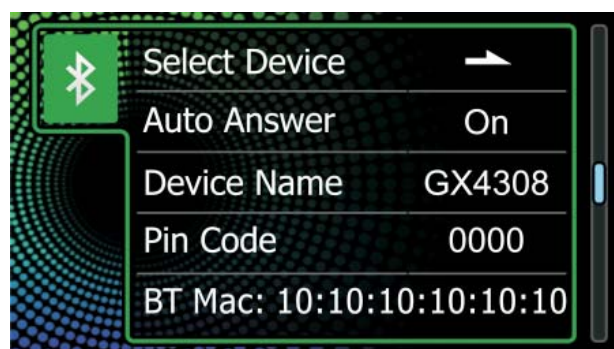



◆ Foretagelse af opkald

Du kan vælge nummer via mobiltelefonen.

1. Brug mobiltelefonen til at vælge nummeret og foretage et udgående opkald.
2. Når nummeret er valgt, vises telefonnummeret og [CALL---].

◆ Modtagelse af et opkald

1. Hvis der er et indgående opkald, vil telefonnummeret blive vist.
2. Tryk på  for at svare/acceptere opkaldet.
3. Når samtalen er slut, trykkes der på  for at afslutte opkaldet.

◆ Viderestilling af opkald

Du kan viderestille samtaler fra bilens højttalere til mobiltelefoner, mens et telefonopkald er i gang. Tryk og hold under en telefonsamtale på  for stemmeviderestilling fra bilhøjttalerne til mobiltelefonen.

◆ Opkaldshistorik

1. Tryk på  og hold den inde for at få vist opkaldshistorikken.
2. Drej  for at vælge elementerne:
 - Liste over opkaldshistorik []
 - Telefonbog []
 - Stemmeassistent []



Du har adgang til stemmegenkendelsesfunktionen for den telefon, der er tilsluttet denne bils AV-system.

1. Tryk på  frontpanelet for at få adgang til indstillingerne for lydtilstand for at justere de forskellige indstillinger
2. Drej  for at vælge de ønskede elementer, der skal justeres, og tryk derefter på  for at bekræfte.
3. Drej  for at vælge en værdi/valgmulighed.

◆ Forudindstil EQ

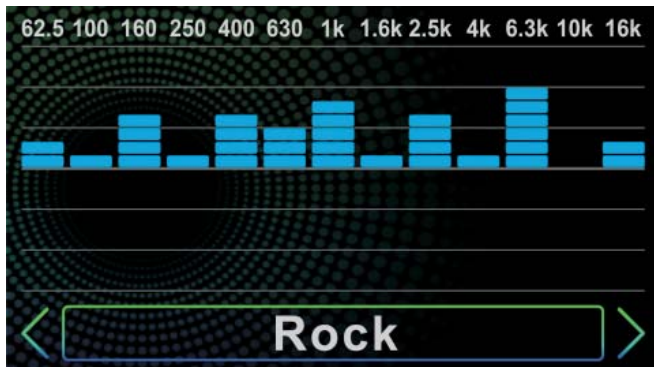

◆ Højtaler

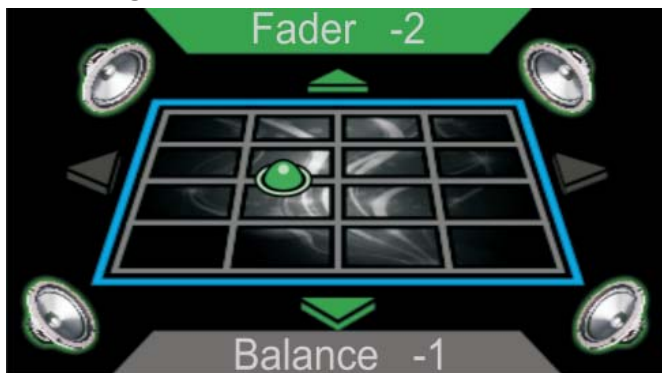

- [Balance]: Juster venstre og højre lydstyrkebalance.
- [Fader]: Juster forreste og bagerste lydstyrkebalance.

◆ XBass

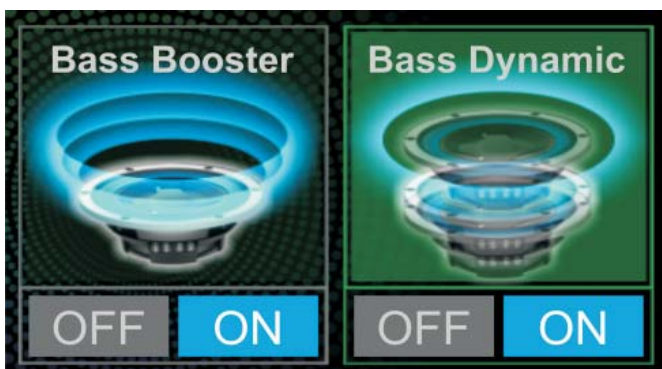

- Indstiller Bass Booster/Bass Dynamic

◆ Crossover



- [Prequence]: Til justering af høj-/lavpasfilter.
- [HÆLDNING]: Til indstilling af en crossover-hældning.
- [NIVEAU]: Til justering af forstækningen i forreste højtaler, bagerste højtaler eller subwooferen.

◆ Virtuel subwoofer



- Indstil de bagerste højtalere til virtuel subwoofer. Nyd den kraftige bas uden at skulle montere en rigtig subwoofer.

◆ Forsinkelse

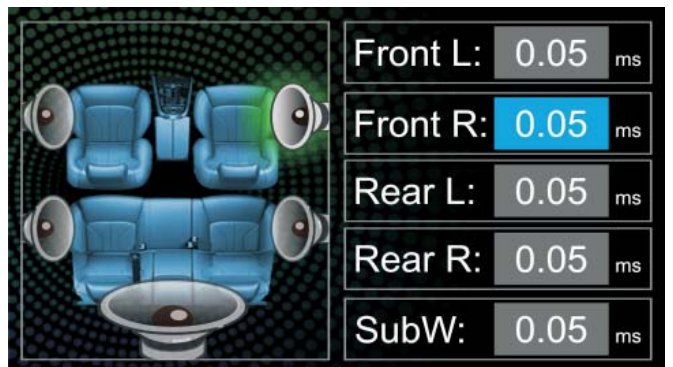

- Juster forsinkelsestiden for den valgte højtaler

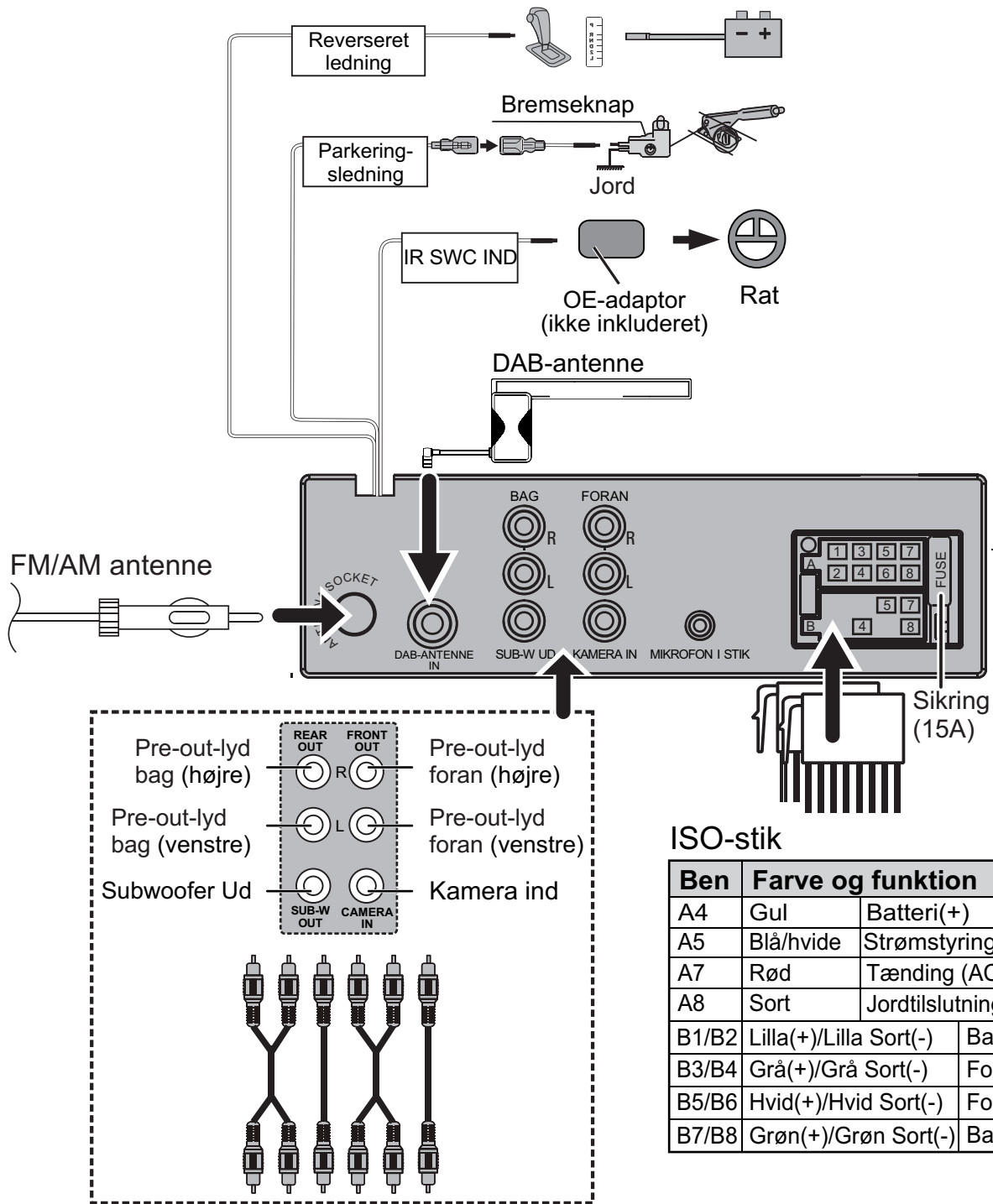

Forrudemonteret DAB-antenne

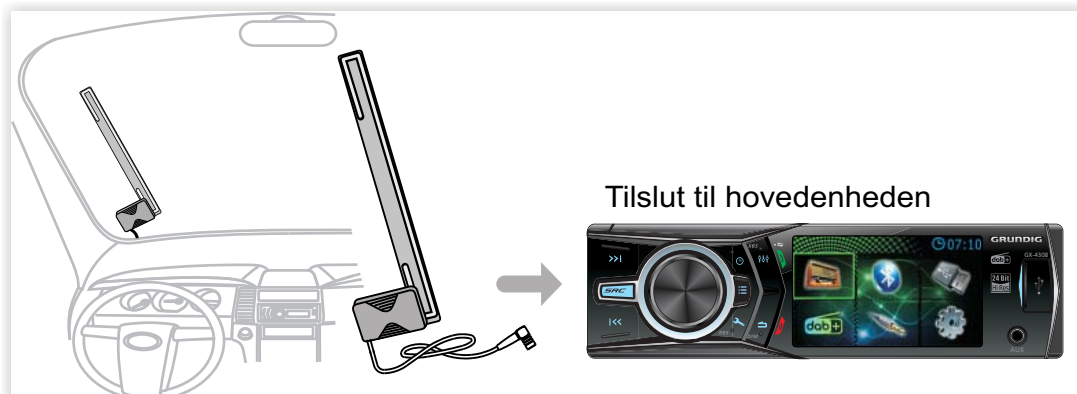

TFT-overvågningsdel

Skærmstørrelse :3.0 tommer
Kontrastforhold :500

USB-grænsefladedel

USB-standard :USB 2.0 Full Speed
File System :FAT 16/32 Maks.
Strøm: :DC 5V=1.5A
D/A-omformer :24Bit

Bluetooth-del

Kommunikations- :Bluetooth Version 4.1
system
Udgang: :Bluetooth
standardstrømklasse
2
Maksimalt : Ca. 10 meter
Kommunikations-
område
Frekvensbånd : 2.4 GHz
Kompatible : HFP/SPP/A2DP/AVRCP
Bluetooth-profiler /PBAP
Understøttede : SBC (Subbåndkode)
koder

Radiodel

FM frekvensområde: 87.5-108.0MHz

AM-frekvensområde: 522-1620 KHz
(MW)

Brugbar : 13.2 uV (FM)
følsomhed : 44.7 uV (AM)(MW)

DAB-del

Frekvensområde : 174-240MHz
Følsomhed : -100dBm(Band III)
Følsomhed : 40dB

Videodel

Farvesystem : NTSC/PAL
Ekstern
videoindgang
Ekstern : 1 Vp-p /75 Ω
videoindgang
(RCA/3,5 m stik)

Lyddel

Maks. udgangseffekt : 50Wx4
Kontinuerlig effekt : 22 Wx4
Udgang (RMS)
Førudgangs niveau : 4V/10k Ω
(V)
Førudgangs impedans : ≤ 1.3k Ω
Højtaler impedans : 4-8 Ω
Udgangsfrekvens- : 20-20000Hz
bånd

Generelt

Driftsspænding :14.4V(10.5-16V)
Drifts- : -20° C--+70° C
temperaturområde
Maks. strømforbrug :15A

Første oppsett

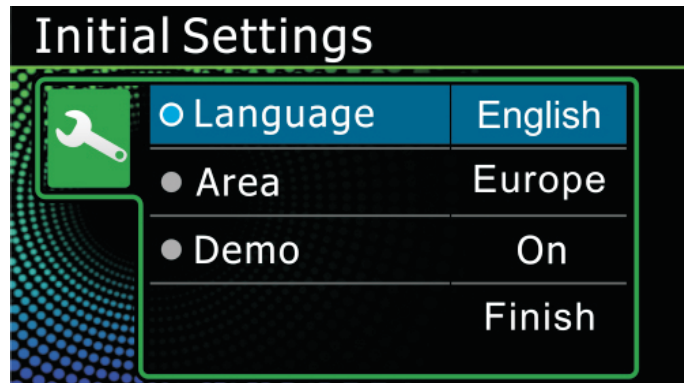
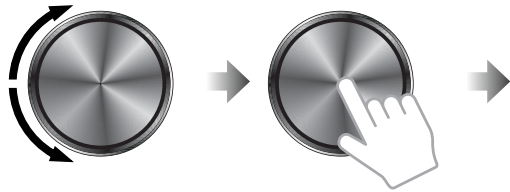

Velg språk/land, og dreii på volumknappen for å velge **Finish** for å bekrefte.



Utfør dette oppsettet når du bruker denne enheten for første gang.

Oversikt over enheten

◆ Funksjonene til knappene på hodeenheten

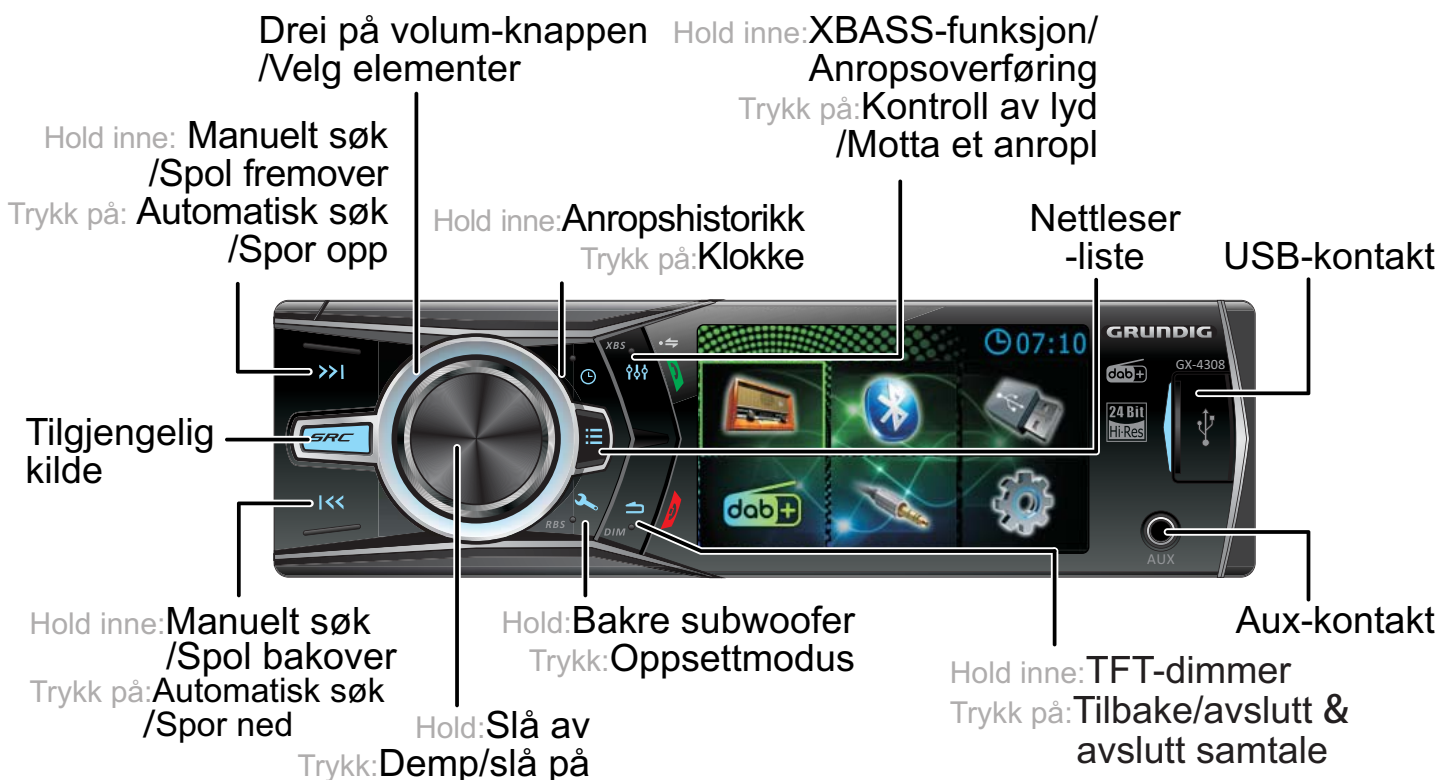

◆ Velg kilde oppsettsmenyen

1. Tilgang til meny



2. Velg kilde



◆ Innstillinger for

Tilgang til oppsettsmenyen

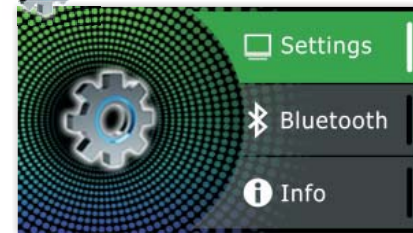

Tilgang til generelle innstillinger

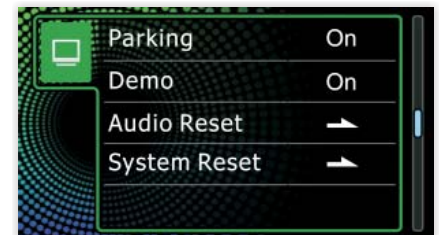
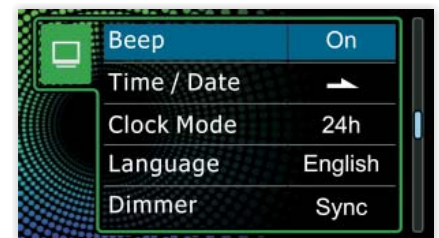

◆ Dempe

Trykk på  -knappen for å dempe eller øke volum.

◆ Justering av volum

Drei på  -knappen på frontpanelet for å øke/reducere volumet.

◆ Klokke

Trykk på  -knappen på frontpanelet for å se klokken.

◆ Dimmer

Trykk og hold inne  -knappen på frontpanelet for å justere LCD-skjermens bakgrunnsbelysning.



◆ Velge radiobåndet

Trykk på -knappen på frontpanelet for å få tilgang til den forhåndsinnstilte listen for å velge bånd.

◆ Manuelt søk

Trykk på [**1<<**] eller [**>>1**] for å stille inn en radiostasjon manuelt. Radiostasjonen sender.

◆ Automatisk søk

Trykk og hold inne [**1<<**] eller [**>>1**] for å stille inn søk etter en radiostasjon automatisk.

◆ Forhåndsinnstilt stasjon

1. Trykk på -knappen på frontpanelet for å vise den forhåndsinnstilte listen.
2. Drei på for å velge forhåndsinnstilt stasjon, og trykk deretter på for å velge.

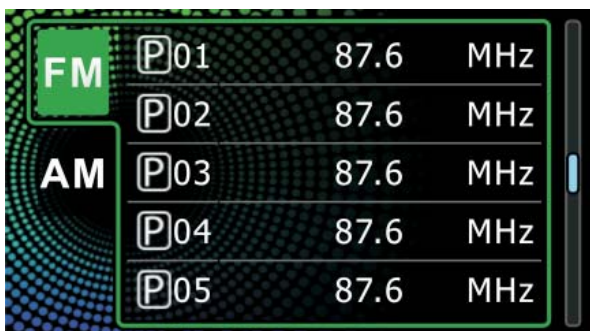

◆ Innstillinger for radiofunksjon

1. Trykk på for å vise menyen for funksjonene.
2. Drei for å velge elementet som skal justeres, og trykk deretter på for å gjøre et valg.

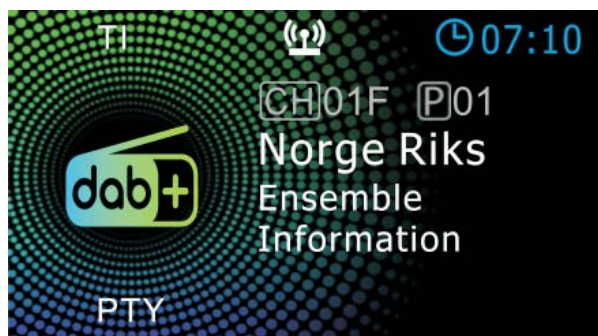

Element	Innstilling som kan velges
Manuell lagring	Lagrer en stasjon manuelt. Mens du lytter til en stasjon du vil lagre, dreier du på volumknappen for å velge et forhåndsinnstilt nummer, og trykker deretter på knappen.
Automatisk lagring	Søker og lagrer stasjonene automatisk med de sterkeste signalene for det valgte båndet.
Område	Velg riktig land for denne enheten: EUROPA, RUSLAND, JAPAN, LATIN-AMERIKA, MIDTØSTEN, OSEANIA, USA, ASIA
Lokalt søk	<ul style="list-style-type: none"> • PÅ: Bare stasjoner med sterkt signal kan sende. Lokal-indikatoren vil lyse. • AV: Stasjoner med både sterke og svake signaler kan sende.
RDS	Slå på eller av RDS-funksjonen.
AF	Når stasjonens mottak er dårlig, bytter automatisk til stasjonen som sender det samme programmet over det samme nettverket for radioens datasystem.
TA	Bytter automatisk til trafikkinformasjonen når trafikkrappporten starter.
CT	Slå på RDS-klokken. Tiden som vises på enheten, synkroniseres med klokketiden til RDS-stasjonen.
PTY	Når du er inne i PTY-modus, trykker du på elementet Kom inn i programtypen, og dreier på koderens volumknapp for valgt kategori.



◆ DAB-radiostasjon manuelt



1. Trykk på [**I<<**] eller [**>>I**] for å søke etter en Grupper automatisk.
2. Trykk og hold inne [**I<<**] eller [**>>I**] gjentatte ganger for å søke etter en gruppe manuelt.

◆ Tjenester for DAB-stasjon

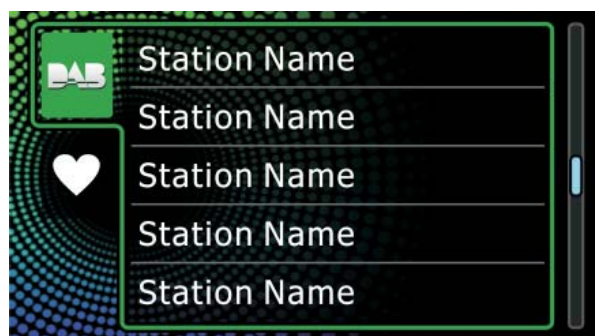
1. Trykk på  -knappen på frontpanelet for å vise listen over tjenester for DAB.
2. Drei på  for å velge en tjeneste, og trykk så på  for å gjøre et valg.





◆ Innstillinger for DAB-funksjoner

1. Trykk på  for å vise menyen for funksjonene.
2. Drei for  å velge det elementet som skal justeres, og trykk så på  for å gjøre et valg.

Element	Innstilling som kan velges
Legg til favoritt	Lagrer en tjeneste Mens du lytter til en tjeneste du vil lagre, dreier du på volumknappen for å velge et forhåndsinnstilt nummer., og trykker deretter på knappen.
Skann etter stasjon	Oppdaterer listen over tjenester for DAB-stasjonen.
Zoom DLS	Vis skjermbildet Dynamisk etikettsegment.
PTY Søk	Søker etter et program etter programtype
TI	Bytter til trafikkinformasjonen automatisk når trafikkrapporten starter
Installasjon	<ul style="list-style-type: none"> • Prioritet Hvis den samme tjenesten leveres av radioens datasystem når mottak av tjenesten som leveres av digital radio blir dårlig, byttes det automatisk til radioens datasystem. • Relatert tjeneste Når du velger PÅ, bytter enheten til en relatert tjeneste (hvis den finnes) når et nettverk for DAB-tjenesten ikke er tilgjengelig. • Strøm fra antenne Setter strømforsyningen til den digitale radioantennen. Sett til "PÅ" når den digitale radioantennen som er i bruk, er utstyrt med en forsterker.
Informasjon	På visningen for DAB-sendingen viser den første linjen stasjonsnavnet, og den andre linjen viser informasjon om tjenesten for den aktuelle stasjonen.
Tilbakestille	Velg [Tilbakestill] og deretter velger du [Ja] for å angi DAB-innstillingene til de første standardinnstillingene.

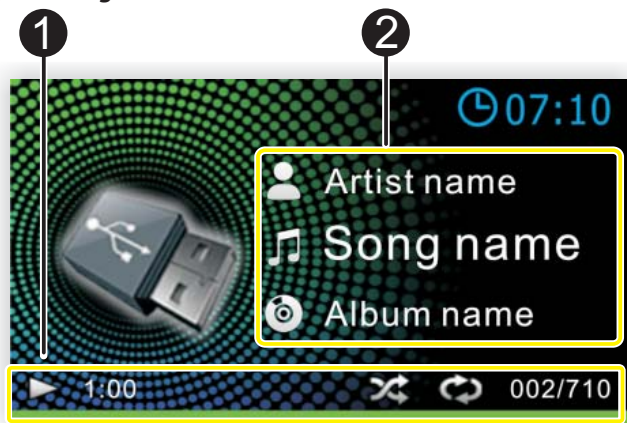
◆ Skjerm





- | | |
|----------|--|
| 1 | <p>Styring av spilletid: For bekreftelse av gjeldende spilleposisjon</p> <p> Gjentatt avspillingsmodus-indikator</p> <p> Tilfeldig avspillingsmodus-indikator</p> |
| 2 | Viser informasjonen til gjeldende fil. |



◆ Spill av / Pause



Trykk på  -knappen for å spille av eller sette lydavspillingen på pause.

◆ Velge et spor

1. Trykk på [/>>]-knappene for å gå til begynnelsen av forrige/neste spor.
2. Trykk og hold inne [/>>]-knappen for å spole fremover/bakover.





◆ Innstillinger for musikkfunksjon

1. Trykk på  for å vise menyen for funksjoner.
2. Drei på  for å velge elementet som skal justeres, og trykk deretter på  for å gjøre et valg.





Gjenta	Alle: Repeterer alle filer() En: Repeterer gjeldende fil() Mappe: Repeterer alle filer i gjeldende mappe()
--------	---

Tilfeldig	Tilfeldig av: Normal avspilling På: Spiller alle filene i tilfeldig rekkefølge()
-----------	--

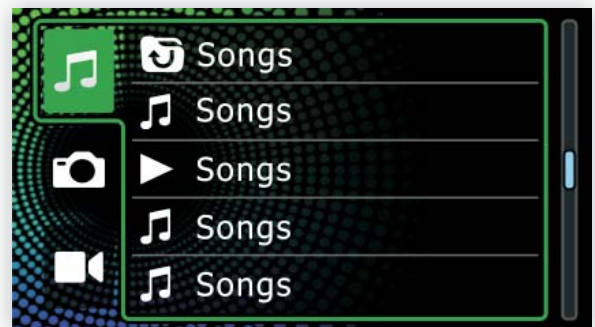
◆ Velge et spor i en liste

1. Trykk på  -knappen på frontpanelet for å vise avspillingslisten
2. Drei på  for å velge elementer:
 - Lydfiler []
 - Videofiler []
 - Bildefiler []



3. Drei på  for å velge ønsket mappe, og trykk deretter på  for å bekrefte.
4. Drei på  for å velge ønsket element, og trykk deretter på  for å starte avspillingen.

◆ Source Screen

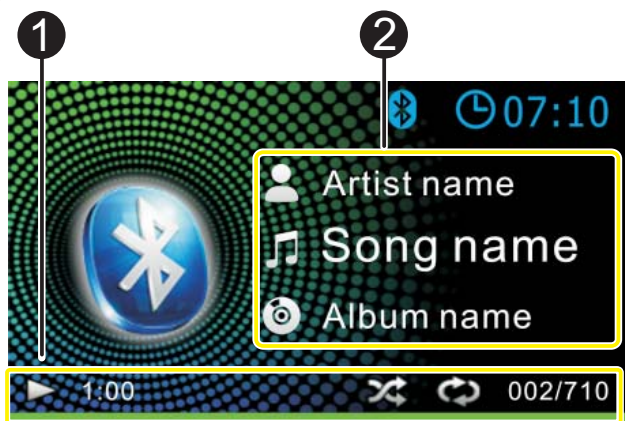

1 **Styring av spilletid:** For bekreftelse av gjeldende spilleposisjon



Gjentatt avspillingsmodus-indikator



Tilfeldig avspillingsmodus-indikator

2 Viser informasjonen til gjeldende fil.

◆ Spill av / Pause

Trykk på -knappen for å spille av eller sette lydavspillingen på pause.

◆ Velge et spor

1. Trykk på [<< / >>]-knappene for å gå til begynnelsen av forrige/neste spor.
2. Trykk og hold inne [<< / >>]-knappen for å spole fremover/bakover.

◆ Innstillinger for musikkfunksjon

1. Trykk på for å vise menyen for funksjoner.
2. Drei på for å velge elementet som skal justeres, og trykk deretter på for å gjøre et valg.

Gjenta	Alle: Repeterer alle filer()
	En: Repeterer gjeldende fil()
	Mappe: Repeterer alle filer igjeldende mappe()

Tilfeldig	Tilfeldig av: Normal avspilling
	På: Spiller alle filene i tilfeldig rekkefølge()

◆ Velge et spor fra en liste

1. Trykk på -knappen på frontpanelet for å vise avspillingslisten.
2. Drei på for å velge om du vil søke etter lydfiler [].

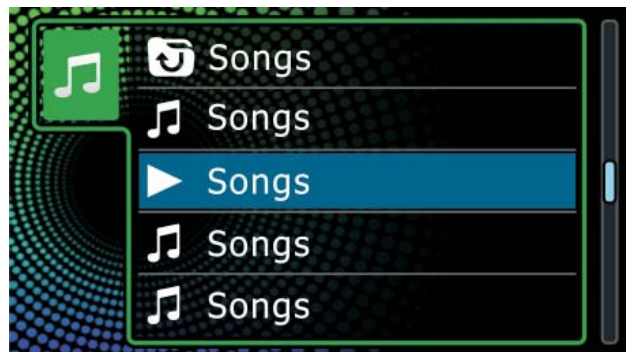

3. Drei på for å velge ønsket mappe, og trykk deretter på for å bekrefte.
4. Drei på for å velge ønsket element, og trykk så på for å starte avspilling.

◆ Bluetooth-innstillinger

1. Trykk på -knappen på frontpanelet for å vise den tilgjengelige kilden.
2. Drei på for å velge innstillingene , trykk deretter på for å bekrefte.

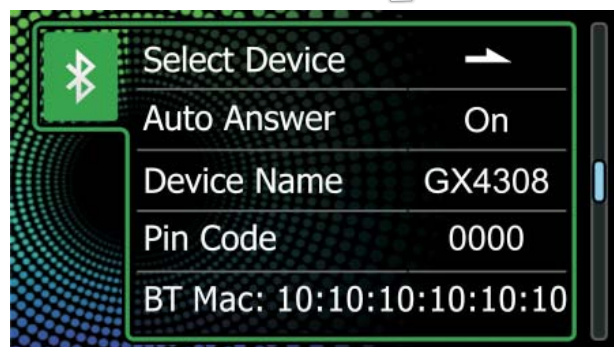



◆ Foreta et anrop

Du kan ringe nummeret via mobiltelefonen.

1. Bruk mobiltelefonen til å ringe og foreta et utgående anrop
2. Når du har fullført oppringingen, vises telefonnummeret og **[ANROP---**].

◆ Motta et anrop

1. Hvis det kommer et innkommende anrop, vil telefonnummeret vises.





2. Trykk på  for å svare på/akseptere anropet.
3. Når samtalen avsluttes, trykk på  for å avslutte anropet.

◆ Anropsoverføring

Du kan overføre lyd fra bilhøytalere til mobiltelefoner under en telefonsamtale. Under en telefonsamtale trykker du på



og holder inne  taleoverføringer fra bilhøytalere til mobiltelefon.

◆ Anropshistorikk

1. Trykk på og hold inne  for å vise anropsloggen.
2. Drei på  for å velge elementer:
 - Liste over anropslogg []
 - Telefonbok []
 - Stemmeassistent []



Du kan få tilgang til talegjenkjenningsfunksjonen til telefonen som er koblet til bilens AV-system.

1. Trykk på  frontpanelet for å få tilgang til lydinnstillingene og justere de ulike innstillingene.
2. Drei på  for å velge hvilke elementer som skal justeres, og trykk deretter på  for å bekrefte.
3. Drei på  for å velge en verdi/alternativ.

◆ Forhåndsinnstill EQ

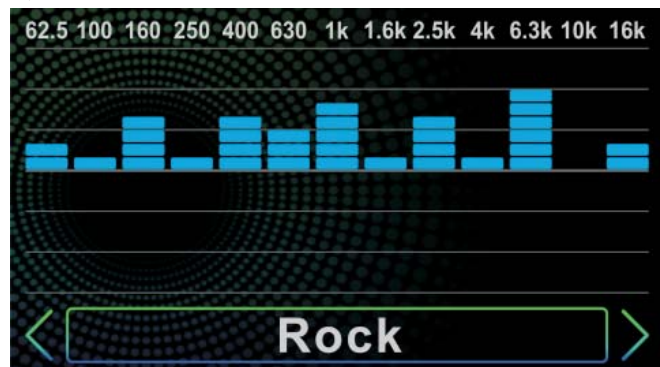

◆ Høyttaler

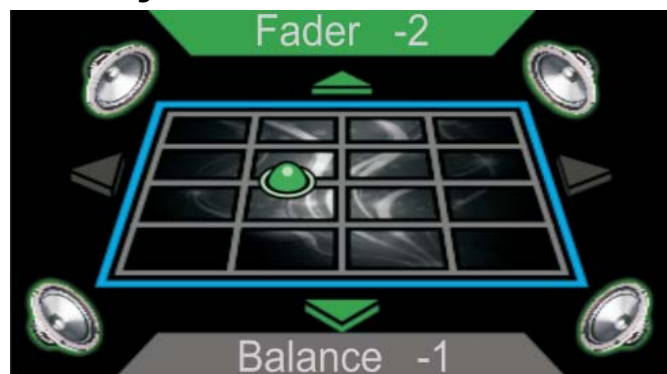

- **[Balanse]**: Juster den venstre og høyre volumbalanse.
- **[Dempingskontroll]**: Juster volumbalansen foran og bak.

◆ XBass



- Angir bassforsterker/dynamisk bass

◆ Crossover



- **[Frekvens]**: For å justere lavpass-og høypassfilter.
- **[HELLING]**: Slik angir du en krysshelling.
- **[NIVÅ]**: For å justere bruken av høyttaler foran og bak, eller basshøyttaler.

◆ Virtuell basshøyttaler



- Vri de bakre høyttalerne til virtuell basshøyttaler. Nyt den kraftige bassen uten å installere en ekte basshøyttaler.

◆ Forsinkelse

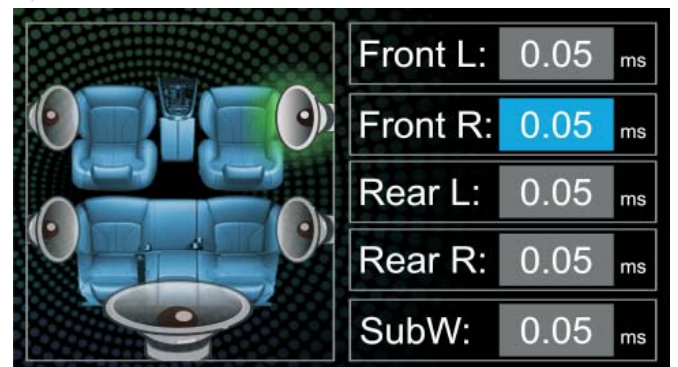

- Juster tidsforsinkelsen for den valgte høyttaleren

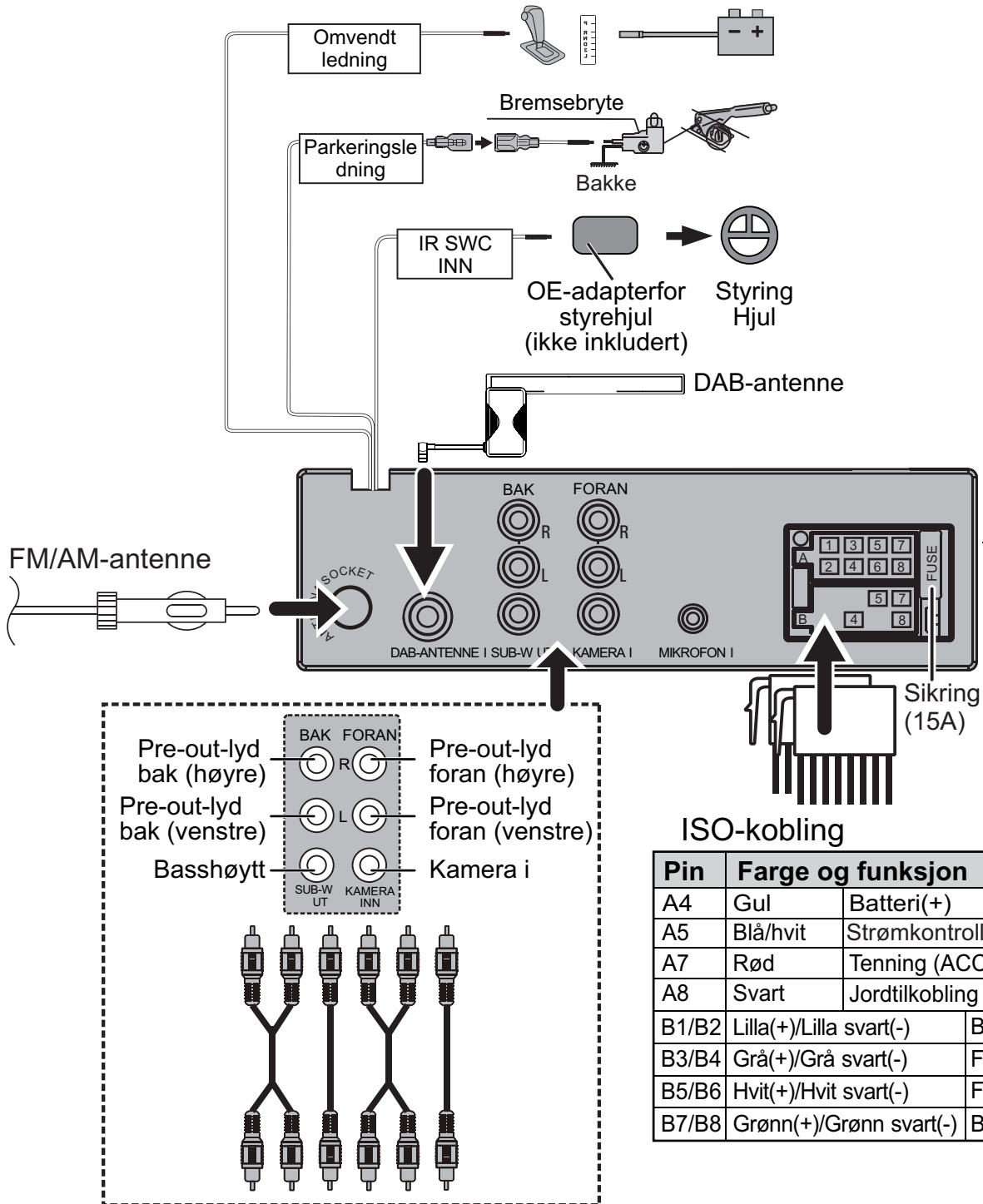

Vindusskjem-montert DAB-antenne

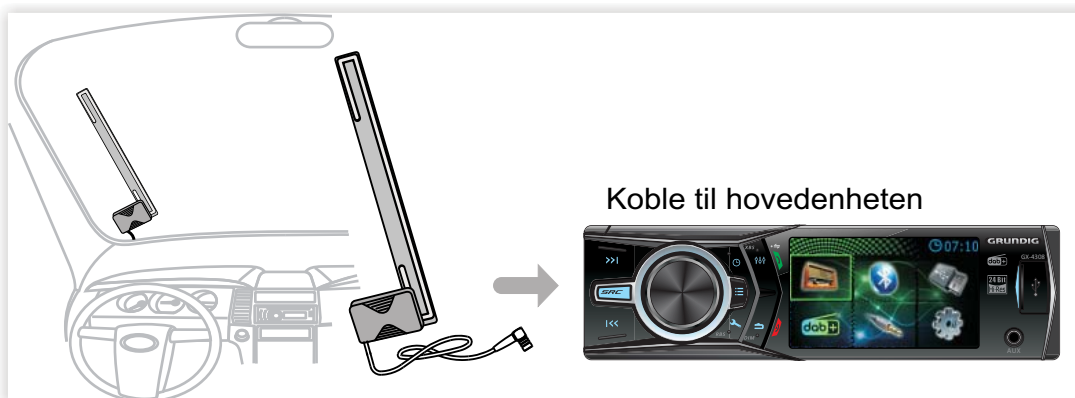

TFT Monitor-seksjon

Skjermstørrelse : 3.0 tommer
Kontrastforhold : 500

Seksjon for USB-grensesnitt

Standard USB : USB 2.0 Filsystem i full hastighet
: FAT 16/32
Maksimal strøm : DC 5V = 1.5A
D/A-omformer : 24Bit

Bluetooth-seksjon

Kommunikasjonssystem : Bluetooth-versjon 4.1
Utgangseffekt : Bluetooth Standard strømklasse 2
Maksimalt Kommunikasjonsområde : Ca. 10 meter
Frekvensbånd : 2.4 GHz
Kompatible Bluetooth-profiler : HFP/SPP/A2DP/AVRCP /PBAP
Kodeker som støttes : SBC (Subbandkodek)

Radioseksjon

Frekvens FM-område : 87.5-108.0MHz
Frekvens AM (MW)-område : 522-1620 KHz
Brukbar følsomhet : 13.2 uV (FM)
: 44.7 uV (AM)(MW)

DAB-seksjon

Område for frekvens : 174-240MHz
Følsomhet : -100dBm(Band III)
Følsomhet : 40dB

Videoseksjon

Fargesystem av Ekstern videoinngang : NTSC/PAL
Ekstern videoinngang : 1 Vp-p / 75 Ω
(RCA/3,5 m kontakt)

Lyd-seksjon

Maks effekt : 50Wx4
Kontinuerlig effekt Utgang (RMS) : 22 Wx4
Pre-out-nivå (V) : 4V/10k Ω
Pre-out-impedans : ≤ 1.3k Ω
yttaler-impedans : 4-8 Ω
Utgangsfrekvensbånd : 20-20000Hz

Generelt

Driftsspenning : 14.4V(10.5-16V)
I drift : -20° C--+70° C
Temperaturområde
Maksimalt strømforbruk : 15A

GRUNDIG

FOR A GOOD REASON

